



## TMdrive<sup>®</sup>-XL80 Product Application Guide

Medium Voltage Drive

metals

cranes

mining

testing

oil & gas

renewable  
energy

power  
generation

cement

# TMdrive-XL80 High-Power Drive

## Electric Compressor Drive Application

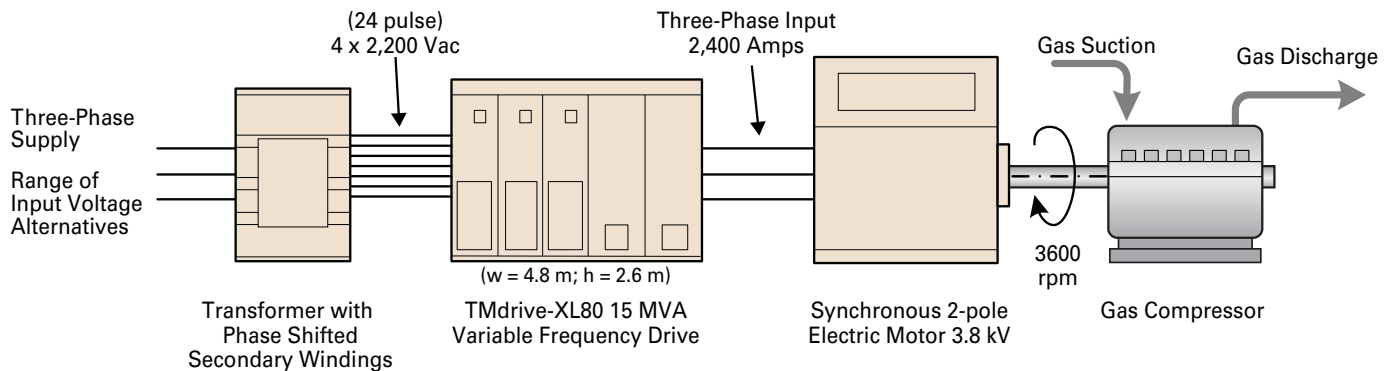







The TMdrive-XL80 variable frequency drive is designed to meet Oil & Gas industry needs for:

- High power
- High reliability
- Output frequency range for direct compressor drive
- Reduced energy consumption

Power Levels using parallel banks of TMdrive-XL80:

- One-Bank – 15 MW
- Two-Bank – 30 MW

Synchronous or induction motors can be driven.

Design Feature	Customer Benefit
 <ul style="list-style-type: none"> <li>• Conservative design using 6000 V–6000 A Gate Commutated Turn-off Thyristors (GCTs)</li> </ul>	<ul style="list-style-type: none"> <li>• Highly reliable operation, expected 20 year drive MTBF</li> </ul>
 <ul style="list-style-type: none"> <li>• High energy efficiency of approximately 98.6%</li> </ul>	<ul style="list-style-type: none"> <li>• Considerable energy savings</li> </ul>
 <ul style="list-style-type: none"> <li>• Diode rectifier ensures power factor greater than 95% in the speed control range</li> </ul>	<ul style="list-style-type: none"> <li>• Capacitors not required for power factor correction</li> </ul>
 <ul style="list-style-type: none"> <li>• 24-pulse converter rectifier by using phase shifted transformer</li> </ul>	<ul style="list-style-type: none"> <li>• No harmonic filter required to provide lower harmonic distortion levels than IEEE-519-1992 guidelines</li> </ul>
 <ul style="list-style-type: none"> <li>• Three level drive output waveform to the motor</li> </ul>	<ul style="list-style-type: none"> <li>• Smooth output voltage, motor friendly wave form</li> </ul>
 <ul style="list-style-type: none"> <li>• Externally mounted input isolation transformer</li> </ul>	<ul style="list-style-type: none"> <li>• Less power loss in drive room</li> <li>• Less total space required</li> <li>• Simplifies design and installation</li> </ul>
 <ul style="list-style-type: none"> <li>• Up to 3.8 kV direct drive voltage output level</li> </ul>	<ul style="list-style-type: none"> <li>• No output transformer required, saving cost, mounting space, and energy</li> </ul>

# Designed for Large Compressors



## Liquefied Natural Gas Plants

LNG plants have large refrigeration compressors driven by high power turbines or electric motors of over 10 MW size and with speeds of over 3,000 rpm. The TMdrive-XL80 combined with TMEIC's two-pole synchronous motor is specially designed for this application.



## Gas Pipelines

Large compressors on gas pipelines require high power and speed – usually provided by gas turbines. Replacing the turbine with an electric motor and TMdrive-XL80 drive provides higher reliability, uptime, and efficiency, and in addition, NO<sub>x</sub> and noise are eliminated.



## Chemical Plants and Refineries

Large compressors requiring over 10,000 hp are found in refineries and chemical plants. The TMdrive-XL80 drive and electric motor offer high-reliability, high-availability, lower pollution, and lower noise level for these applications.



## Steel Plants

Steel plant blast furnaces use large air flows requiring high power levels, which can be supplied by the TMdrive-XL80 drive.

# A Look Inside

## Advanced Technology for High Power

- World's largest Gate Commutated Thyristor (GCT) rated for 6000 A and 6kV, provides high-speed switching
- Water-cooling technology for the power bridge reduces drive footprint, saving valuable space
- Modular design power bridge minimizes time for any maintenance activities

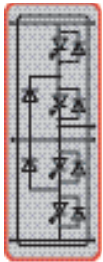

### GCT Cell Stack Assembly

The drive has a total of six GCT cell stack modules in the inverter. The modular draw-out assembly includes:

- Four GCT power semiconductors
- Four fast recovery diodes
- Two neutral-point clamp diodes
- Water cooling piping with quick disconnect fittings
- GCT gate driver circuit board

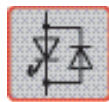
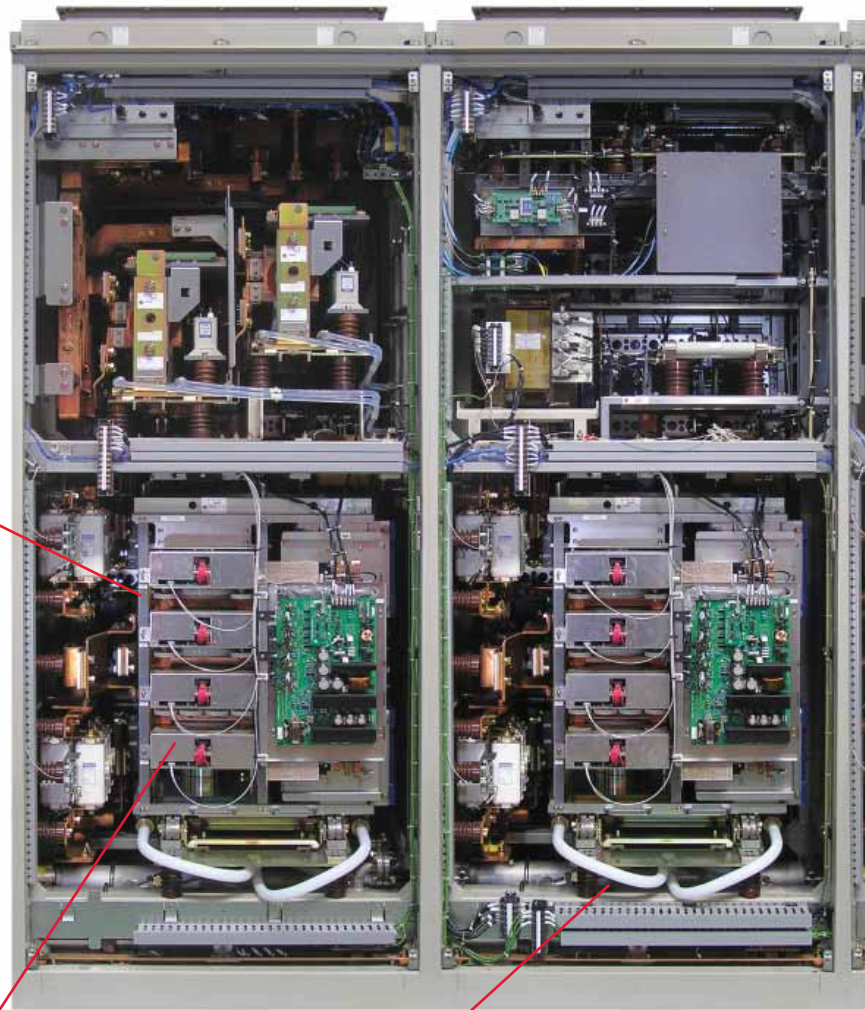

GCT Stack

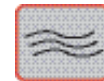

Water Cooling Tubes for Cell Stack Assemblies

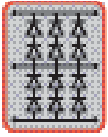

**Diode Rectifier  
DC Source Module**

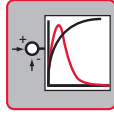

**Main Control Panel**

The primary control board provides:

- Volt/Hz control
- Sequencing
- Diagnostic data gathering
- Optional LAN interface board

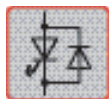
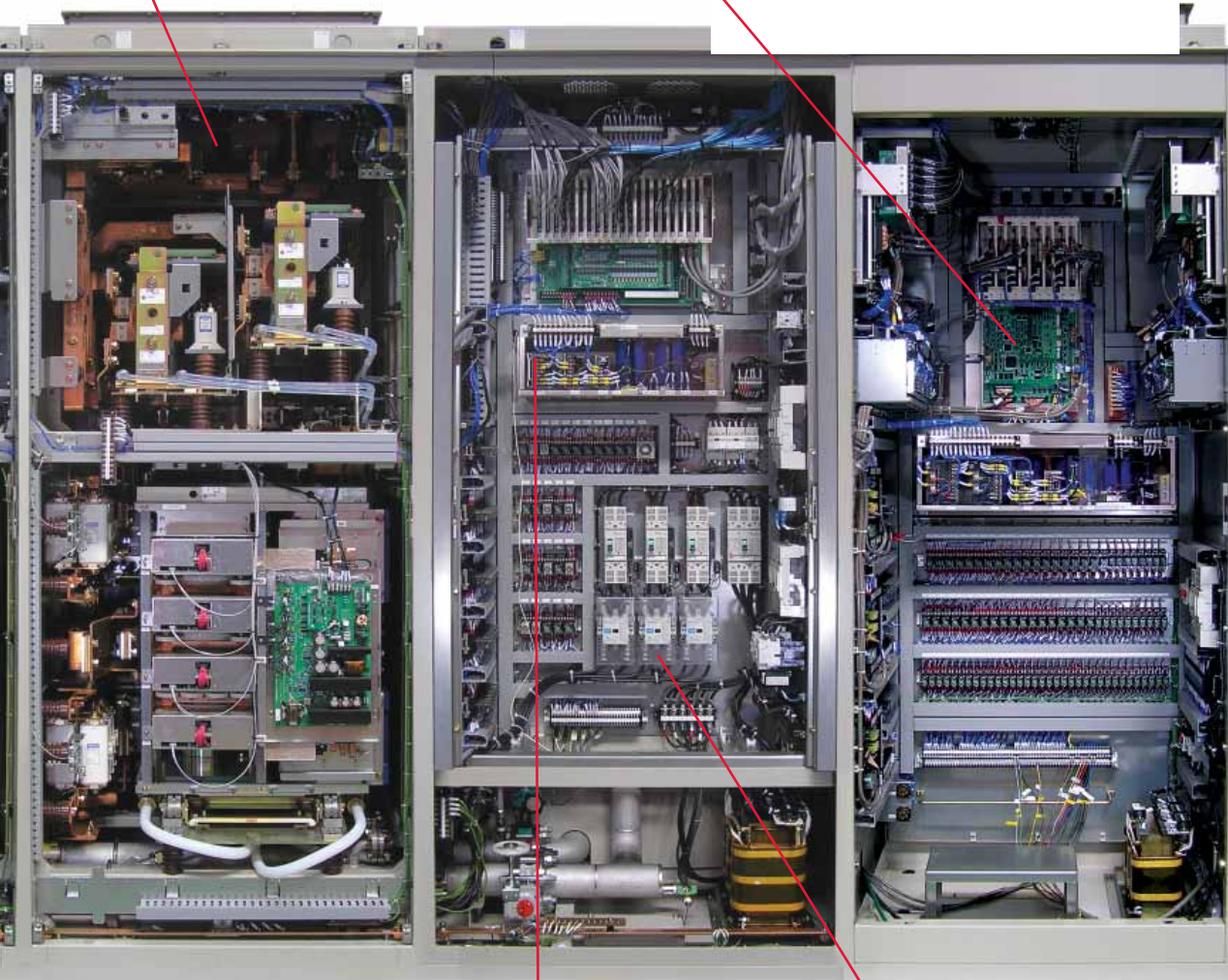

**Gate Drive  
Panel**

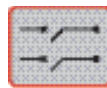

**Control  
Power  
Distribution**

# TMdrive-XL80 Architecture

TMdrive-XL80 high-power level architecture consists of:

- One diode rectifier modules per phase
- One inverter module per phase
- Phase shifted transformer externally mounted

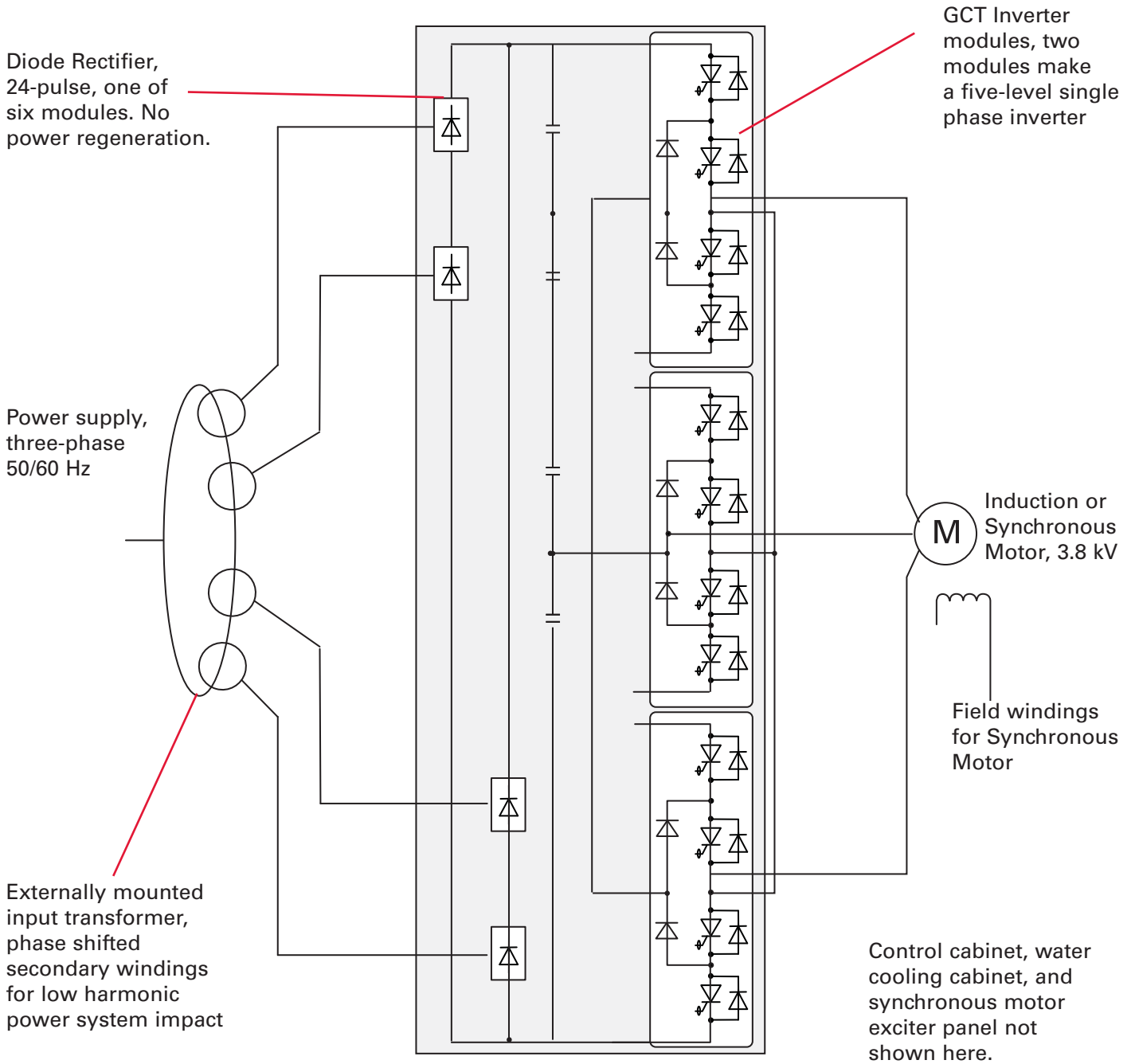

## GCT Inverter Module

This inverter module has two Gate Commutated turn-off thyristors rated for 6,000 amps and 6,000 volts. Two modules make one inverter phase assembly.

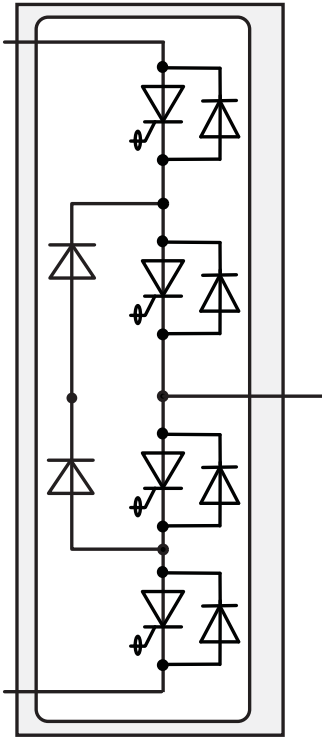

GCT Assembly showing firing circuits and control board, four per half-module

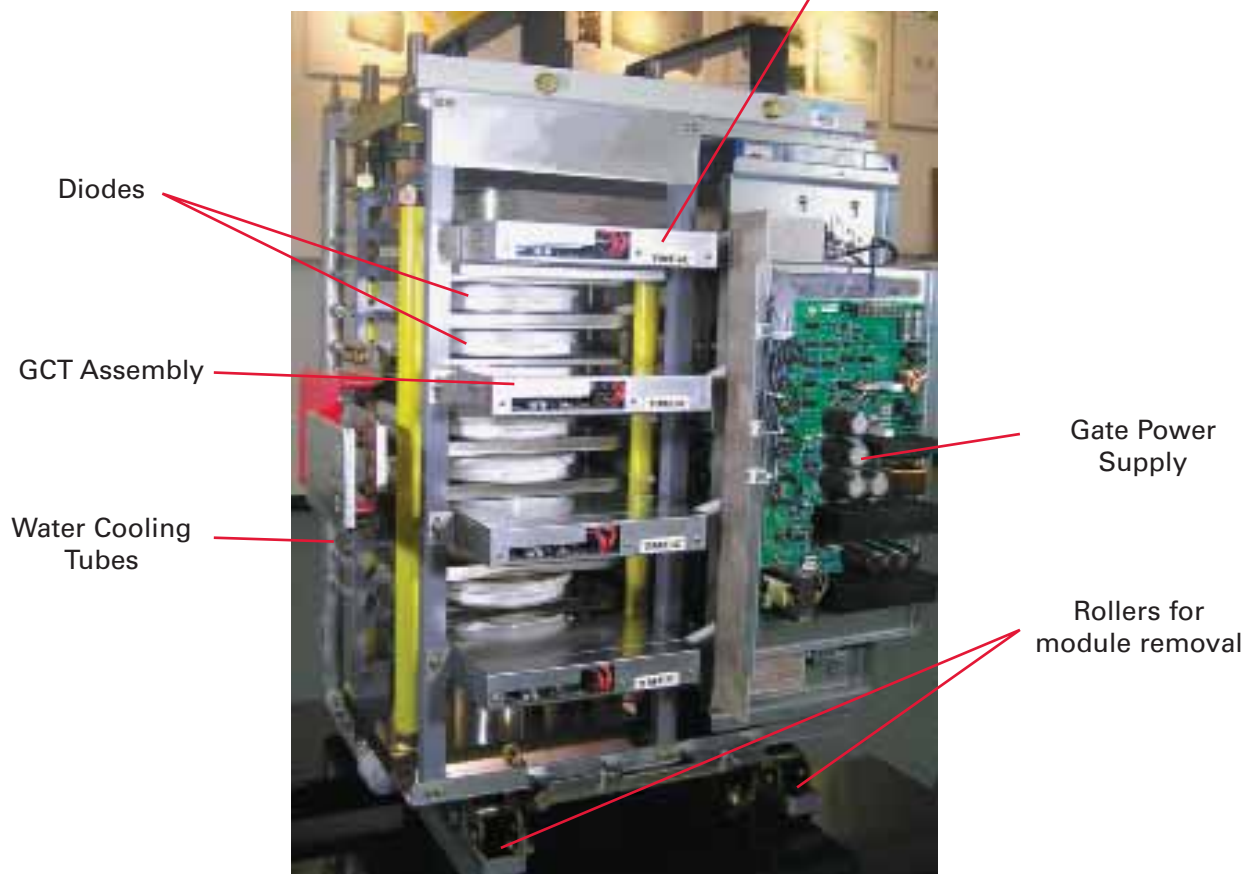

# Drive Panel Line Up



## TMdrive-XL80 Single Bank Cabinet Line-Up

### Top View

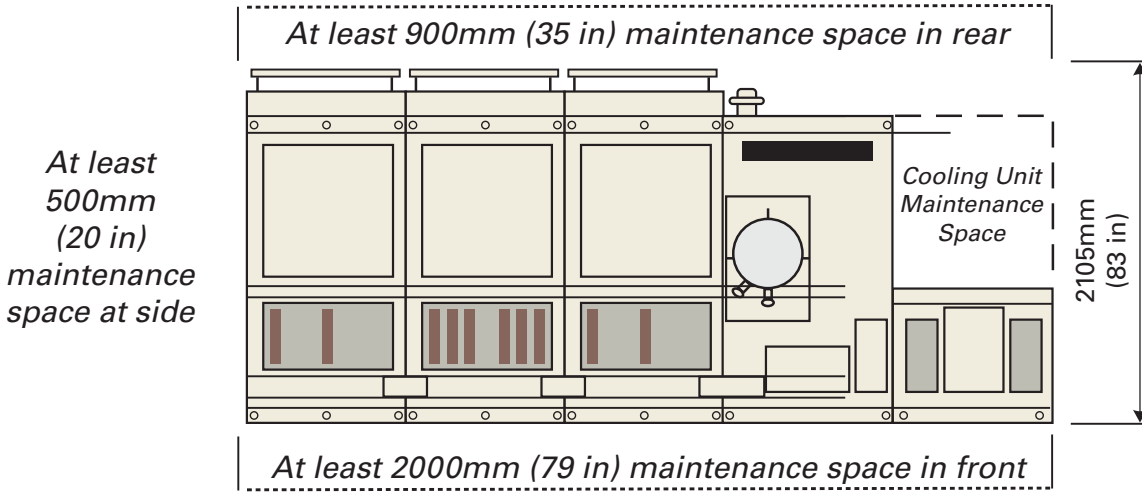

### Front View

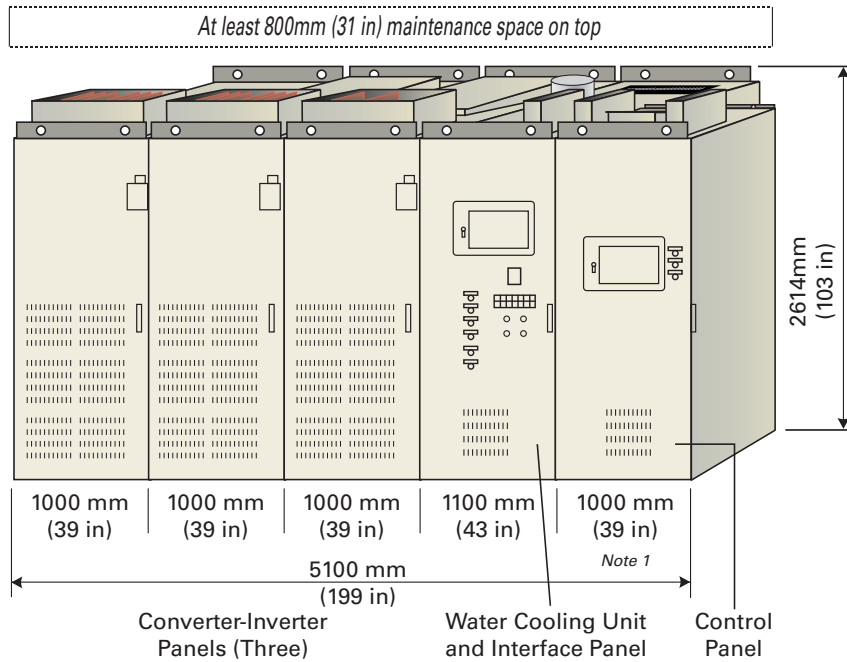

### Drive Specifications

	Voltage kV	Power MVA	Motor Current A	Height mm (in)	Width mm (in)	Depth mm (in)	Weight kg (lbs)
Single Bank Drive	3.8	15	2400	2614 (103)	5100 (199)	2105 (83)	15000 (33070)

Dimensions shown are for a 15 MVA (15,000 kVA) single bank drive.  
 Power outputs up to 30 MVA will use multiple banks similar to above.  
 Weight is for line-up with no water, and does not include exciter panel.

Note 1: Compact type control panel (W800mm) is available for a single-bank of TMdrive-XL80



# High-Power Levels Using Parallel Banks

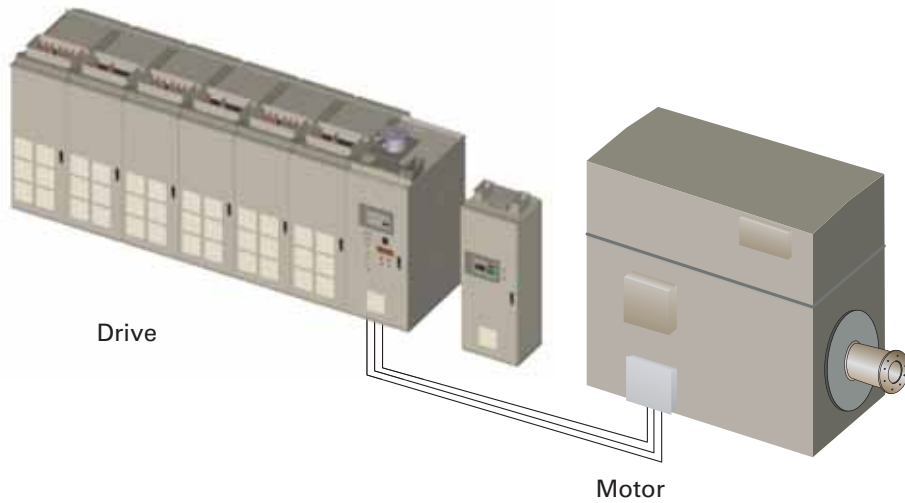

## One-Bank XL80 Variable Frequency Drive

- Power level 15 MW
- One cooling water panel with included interface panel
- Synchronous motor 3.8 kV
- Drive input transformers not shown

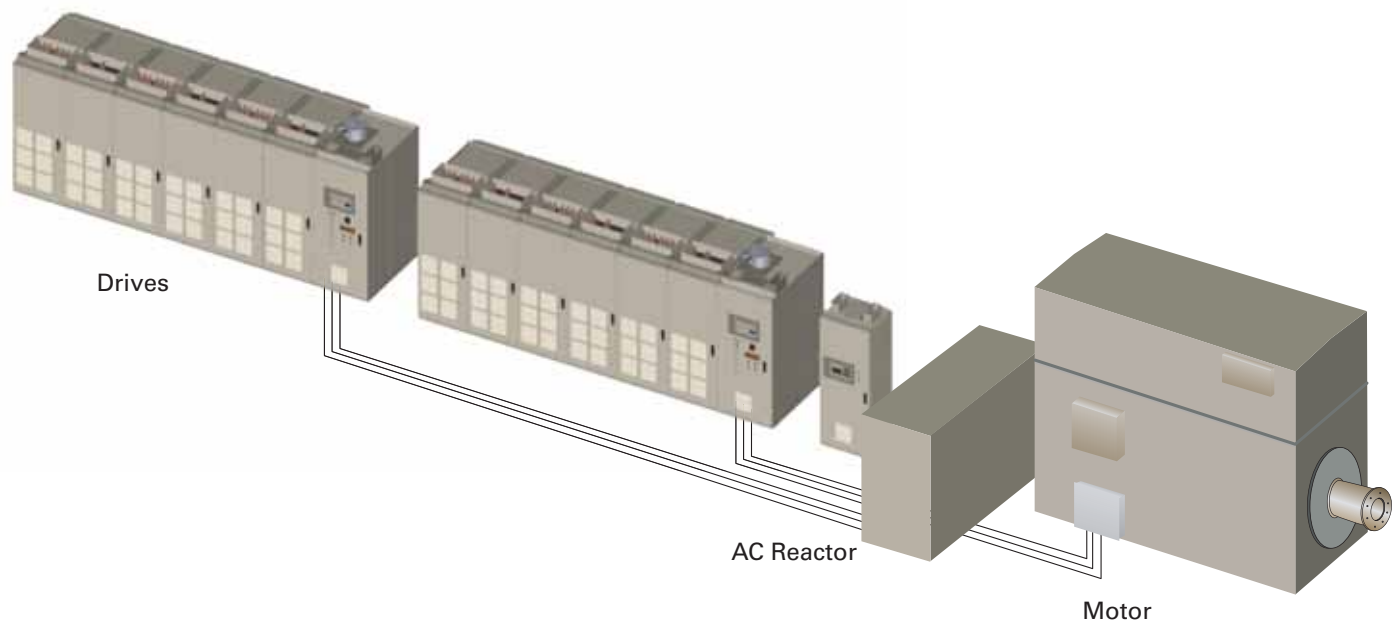

## Two-Bank XL80 Variable Frequency Drive

- Power level 30 MW
- Single control cabinet. Two cooling water panels with included interface panel
- Synchronous motor 3.3 kV; paralleling reactor feeds the motor
- Drive input transformers not shown

# Features of the TMdrive-XL80

## A Clean Wave Inverter

Using the multiple winding input transformer, the TMdrive-XL80 has 24-pulse rectification, which reduces the harmonic voltage distortion on the power source and protects the other equipment in the plant. The harmonic current content measured in an actual load test is compared with IEEE-519 in the chart opposite, showing it more than meets the standard.

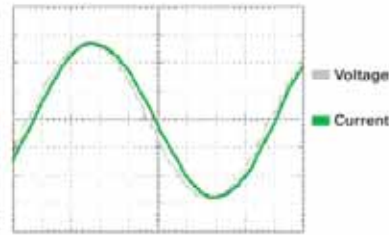

Drive Input Wave forms

## A Clean Output Wave

As a result of the five-level PWM control, the output current waveform is close to a sine wave, and the heat loss in the windings caused by harmonics is negligible. In addition, harmonic currents in the motor are minimized so there is very little torque ripple on the output shaft.

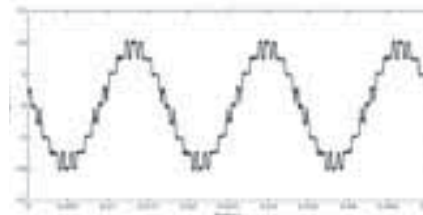

Line to Line Voltage Output Waveform

new?

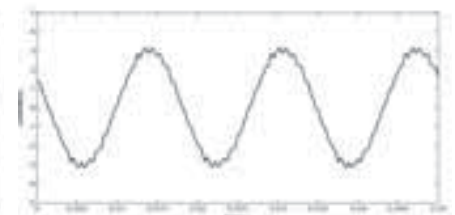

Phase Current Output Waveform

## A Higher Efficiency than Conventional Drives

Actual factory load tests show the drive efficiency is approximately 98.6% (design value). This high efficiency is a result of:

- A smaller number of switching semiconductors by using 6kV GCTs
- Lower switching frequencies using multilevel PWM control reduce the switching loss of each GCT
- Direct connection of 3.8 kV motor without an output transformer

## A High Input Power Factor

As a result of the diode bridge rectifier, the input power factor is above 95% over the entire normal operating speed range, even when driving a multiple-pole induction motor of low power factor. With this high power factor, no power factor correction capacitor is required.



## Environmental

Operating Air Temperature	0 to 40°C (32 to 104°F) at rated load 0 to 45°C (32 to 113°F) with derating
Storage Temperature	-25 to 70°C (-13 to 158°F)
Humidity	5 to 95% relative humidity Non-condensing
Altitude	Up to 1000 m Up to 3000 m with derating
Vibration	10-50 Hz, <0.5 G IEC 61800-4 5.1.22
Industrial Water Temperature	0°C - 40°C at inlet 0°C - 45°C at inlet with derate

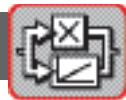

## Motor Control

### Volt/Hertz Control

- Frequency control accuracy:  
+/- 0.5% (analog setting)
- Frequency setting resolution:  
1/1000 or more (analog setting)
- Normal torque:  
Below 50% frequency, squaring load  
Below 50% frequency, 100% load

### Pulse Width Modulation Control

- 0-25% speed, Asynchronous PWM
- 25-50% speed, Synchronous PWM
- 50-100% speed, Fixed Pulse Width

Variable Switching frequency up to 600 Hz

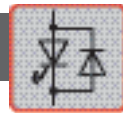

## Power Input/Output

Input Voltage	3 x 2 x 2105 V ±10% 50/60 Hz ± 2%
Input Harmonics	IEEE 519 compliant without filters
Power (for Pre-charge, Gate Power, Cooling Fan, IRU, Relay)	220 V (50/60 Hz) 3-phase without transformer 200 V (50 Hz) 380/400/440/460/480/575/690 V using transformer
Cooling Pumps	380 V-50 Hz 400 V-50/60 Hz 440 V-60 Hz 200/220/460/480/575/690V-60 Hz
Displacement Power Factor	.95
Output Voltage	3800 Vac
Output Current	2400 A rms
Output Current Derating	Ambiant Temp. Derating 40°C 1.00 45°C 0.94
Output Frequency	50-60 Hz, 50-200 Hz with derate above 100 Hz
Output Chopping Frequency	600 Hz (max)
Efficiency	98.6%



## Standard Connection

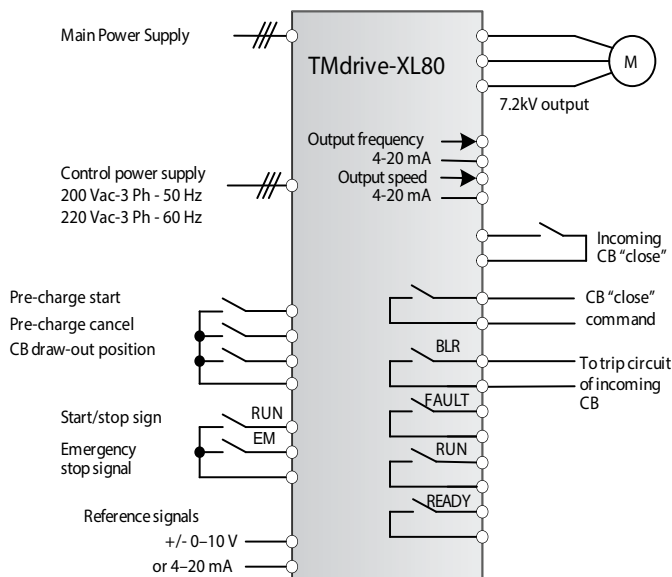

Control Area	Specifications
Analog Inputs	(2) $\pm 10$ V or 4-20 mA, configurable, differential, 12-bit Sampling time 1 ms
Analog Outputs	(4) $\pm 10$ V or 8-bit, configurable, 10 mA max, 12-bit Sampling time 1 ms
Digital Inputs	(2) 24-110 V or 48-120 V ac; (6) 24 V dc, configurable
Digital Outputs	(6) 24 V dc open collector 50 mA
Speed Feedback Resolver Input	Not provided as standard
LAN Interface Options	Profibus-DP, ISBus, DeviceNet™, TC net, or Modbus RTU
Motor Temperature Sensor	High-resolution motor temperature feedback: 1 k Ohm platinum resistor or 100 Ohm platinum RTD (uses analog input with signal conditioner)

## Specifications

### Converter type

- AC-fed multi-pulse diode using phase shifted transformer
- DC bus voltage: 5700 Vdc

### Transformer

- Oil immersed type transformer
- Air cooled type
- Multi windings

### Inverter

- Three-level inverter for motor friendly wave form
- Motor voltage: 3800 V
- Rated frequency: 50/60Hz
- 200Hz, maximum frequency
- Minimum rated frequency 50Hz

### Applicable Standards

- IEC61800-4, JIS, JEC, JEM, (option), CSA (option)
- IEC 60146-1, **18.5 kV for 1 minute withstand**

### Control

- Nonvolatile memory for parameters and fault data
- Volt/Hertz control
- Sensorless vector (option)

### Protective Functions include:

- Inverter overcurrent, overvoltage
- Low or loss of system voltage
- Motor ground fault
- Motor overload
- Cooling fan abnormal
- Over-temperature
- CPU error
- Water cooling unit alarm
- Exciter fault
- DC voltage drop
- Motor inverse rotation
- Stall detection
- Ground detection

### Enclosure

- IP42 except for tan openings (IEC 60529), NEMA 1 gasketed equivalent
- Color: Munsell 5Y7/1 (Option: ANSI 61 gray, RAL7032 etc.)

### Cable Entrance

- Top access standard
- Bottom access – consult factory

### Air Filters

- Air filters on front and rear doors can be replaced with door closed

### Sound

- Average is below 80 dBA one meter from cabinet

# Cooling Water Conditioning Equipment



Water conditioning control panel continuously monitors the status of the water system. Separate fault indications help find and fix problems fast. Operator panel shown on page 15.

Water to water heat exchanger keeps the de-ionized system isolated from the plant water supply.

Redundant pumps keep the system running even if one pump fails

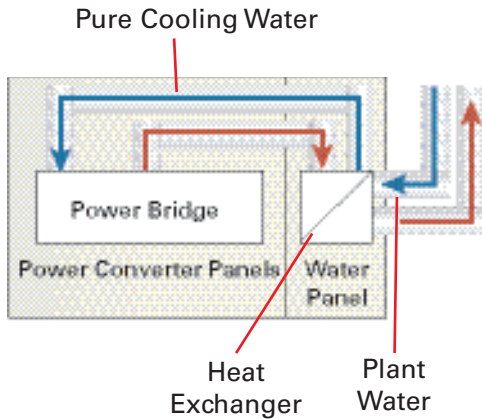

De-ionizer removes contaminants from the internal cooling loop.

Water conditioning system behind Gate Drive Panel

## Cooling Equipment Panel

Type	Heat Exchange Capacity kW	Width mm (in)	Depth mm (in)	Height mm (in)	Weight kg (lbs)	Power Supply kVA	Notes
Single Bank Drive	210	1100 (44)	1800 (71)	2614 (103)	2300 (5060)	24	Capacity for one bank. Plant water required: 1100 l/min (297 gal/min)

## Inlet Cooling Water Temperature Requirements & Power Derating

Cooling Water	Maximum Water Temperature °C (°F)
	One Bank
Cooling water supplied by plant (Industrial water)	40 (104)
Cooling, de-ionized water flowing through the power unit (Pure water)	47 (116)
Cooling, de-ionized water flowing through the power unit (Pure water) - Alarm temp.	48 (118)
Cooling, de-ionized water flowing through the power unit (Pure water) - Fault temp.	50 (122)

Industrial Water Temperature at the Cooler Inlet	
Temperature °C (°F)	Drive Output Current Derating Factor
32 (90)	1.00
40 (104)	1.00
45 (113)	0.90

# Operator Interfaces

## Standard Display

Compact Control Panel (Single Bank or Two Banks)

Pump Panel Screen

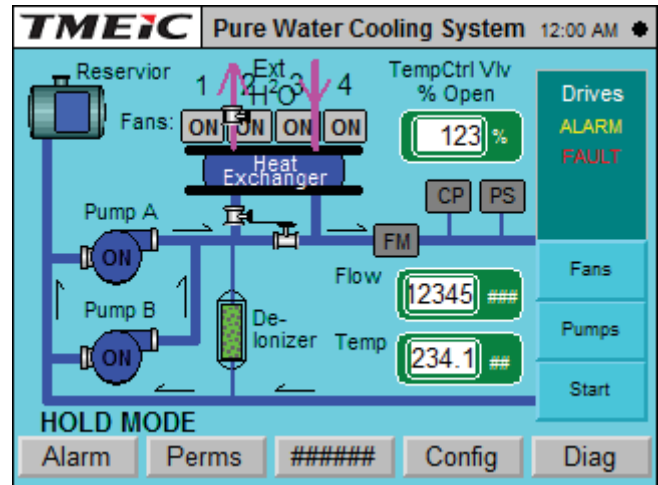
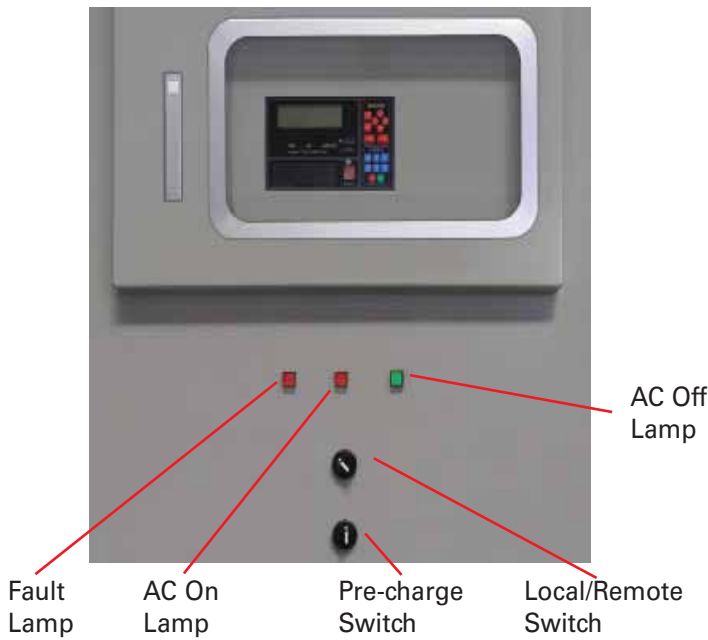

## Keypad

### High Function Display

- LCD backlight gives great visibility and long life
- Bar graphs, icons, menus, and digital values combine to provide concise status information, often eliminating the need for traditional analog meters



Easy-to-understand navigation buttons allow quick access to information without resorting to a PC-based tool

Switch to local mode and operate the equipment right from the keypad

Interlock button disables the drive

### Instrumentation Interface

- Two analog outputs are dedicated to motor current feedback
- Five analog outputs can be mapped to variables for external data logging and analysis

RJ-45 Ethernet port is used for the local toolbox connection

# TMdrive-XL Drive and Motor Test Facility – 30 MVA

## Back-to-Back Tests

The TMdrive-XL series has been thoroughly tested under full load conditions in TMEIC's new test facility shown below. For the 15 MW back-to-back tests, TMEIC designed a 15 MW synchronous two-pole motor for 3600 rpm operation and a 15 MW synchronous four-pole generator for 1800 rpm operation. Power from the generator is sent to four regenerative TMdrive-70 drives which regenerate 15 MW to drive isolation transformers. The output of these transformers match the 11 kV main power grid.

With this test stand, full load and speed can be applied to the drive and motor while the total test power requirements only need to make up power for the electrical losses. The drives new five-level inverter topology and sophisticated Pulse Width Modulation control can be fully tested.

15 MW TMdrive-XL80 five-level GCT drive to power the motor

Regenerative TMdrive-70 three-level IEGT drive to recirculate power back to the supply



Drive Test Data

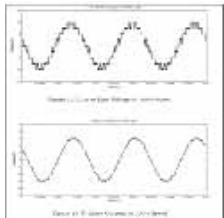

Drive output voltage and current at full speed

Drive Power MW



Motor Speed RPM

Center display: drive output volts to motor

25 MW synchronous 2-pole variable speed motor, 3600 rpm

Gearbox, 2:1 ratio

Synchronous 4-pole generator

The results of these tests demonstrate the suitability of electric drive systems for large compressor applications. Desirable features are proven, such as a clean output waveform at full speed and generation of very little output torque ripple.

# TMEIC Drives Offer Complete Coverage

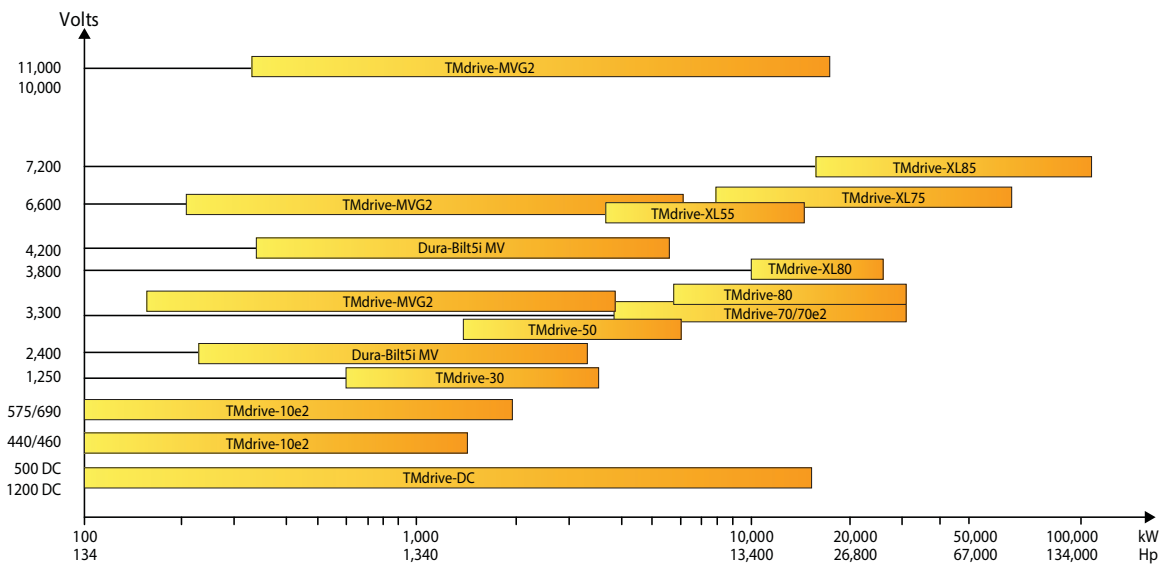

## Global Office Locations:

### TMEIC Corporation

Office: 1325 Electric Road, Roanoke, VA, 24018, USA  
 Mailing: 2060 Cook Drive, Salem, VA, 24153, USA  
 Tel.: +1-540-283-2000; Fax: +1-540-283-2001  
 Email: info@tmeic.com; Web: www.tmeic.com

### TMEIC Corporation - Houston Branch

2901 Wilcrest Dr., Houston, TX 77042, USA  
 Tel.: +1-713-784-2163; Fax.: +1-713-784-2842  
 Email: OilGas@tmeic.com; Web: www.tmeic.com

### TMEIC Power Electronic Products Corporation

13131 W. Little York Road, Houston, Texas 77041, USA

### Toshiba Mitsubishi-Electric Industrial Systems Corporation

Tokyo Square Garden  
 3-1-1 Kyobashi, Chuo-kyo, Tokyo, 104-0031, Japan  
 Tel.: +81-0-3327-5511  
 Web: www.tmeic.co.jp

### TMEIC Europe Limited

6-9 The Square, Stockley Park, Uxbridge, Middlesex,  
 United Kingdom, UB7 7LT  
 Tel.: +44 870 950 7220; Fax: +44 870 950 7221  
 Email: info@tmeic.eu; Web: www.tmeic.com/Europe

### TMEIC Industrial Systems India Private Limited

Unit # 03-04, Third Floor,  
 Block 2, Cyber Pearl, HITEC City, Madhapur,  
 Hyderabad, 500081, Andhra Pradesh, India  
 Tel.: +91-40-44434-0000; Fax: +91-40-4434-0034  
 Email: inquiry\_india@tmeic.com; Web: www.tmeic.in

### Toshiba Mitsubishi-Electric Industrial Systems Corp (Beijing)

21/F, Building B, In.do Mansion, 48 Zhichunlu A, Haidian  
 District, Beijing 100098, PRC  
 Tel.: +86 10 5873-2277; Fax: +86 10 5873-2208  
 Email: sales@tmeic-cn.com

### TMEIC – Sistemas Industriais da América do Sul Ltda.

Av. Paulista, 1439 cj72  
 Bela Vista, CEP:01311-200  
 São Paulo/SP, Brasil  
 Tel: +55-11-3266-6161; Fax: +55-11-3253-0697

*TMdrive is a registered trademark of TOSHIBA MITSUBISHI-ELECTRIC INDUSTRIAL SYSTEMS CORPORATION.*

*All other products mentioned are registered trademarks and/or trademarks of their respective companies.*

*All specifications in this document are subject to change without notice. The above brochure is provided free of charge and without obligation to the reader or to TMEIC, and is for informational purposes only. TMEIC does not accept, nor imply, the acceptance of any liability with regard to the use of the information provided. TMEIC provides the information included herein as is and without warranty of any kind, express or implied, including but not limited to any implied statutory warranty of merchantability or fitness for particular purposes. The brochure is not an implied or express contract.*